

Specifications

Model # : LJ823F
3/4" X 3/4"PC FNPT Female Elbow

- **Material:** Forged Lead Free Brass
- **Maximum: Working Pressure** 250 PSI [17.3 bar]
- **Maximum: Temperature Rating** 250 °F [121 °C]

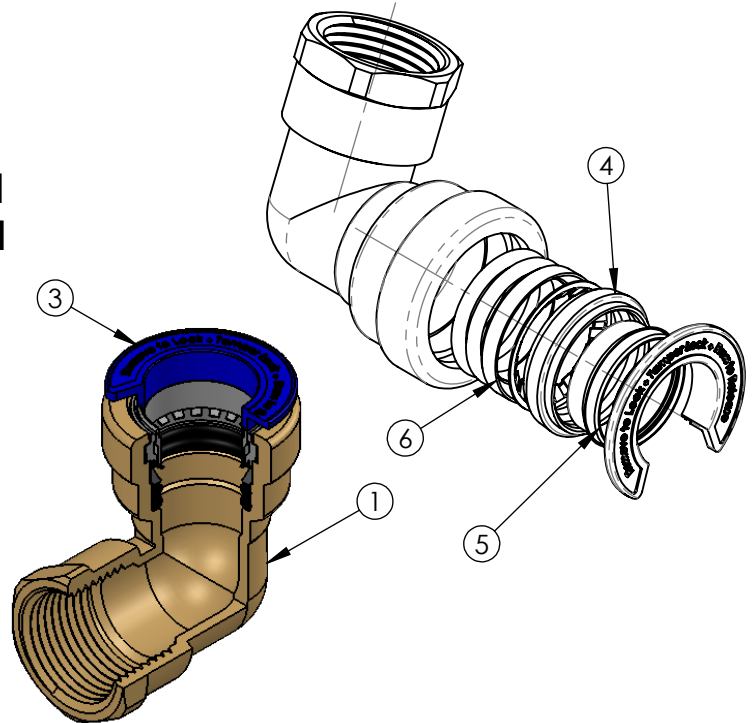
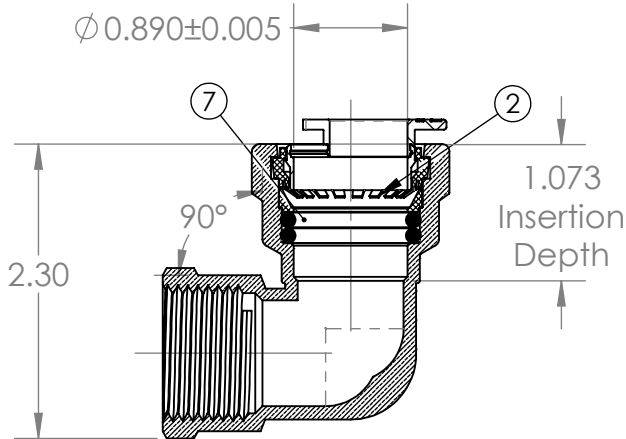

Features:

- Patented Dual Seal (100% More Sealing Surface)
- 75 Year Warranty
- Highest Pressure and Tensile Performance
- Compatible With Copper, CPVC, PEX & PE-RT
- Push to Connect Patented Design
- Removable Integrated Release Tool
- USA Grip Technology
- Patent Pending Tamper Resistant Technology
- Proprietary Lead Free Brass (DZR)
- Removable and Re-usable
- Assembled & Packaged in the USA
- Replaceable O-Ring Seal Design

Approved Applications:

- Plumbing
- Heating
- Irrigation
- Underground
- Hydronic Heating
- Behind Walls without Access Panel

Certifications

- cUPC
- ASSE1061 - 2011
- NSF/ANSI 61
- Lead Law Compliant
- IAPMO Listed

MATERIALS & SPECIFICATIONS

NO.	COMPONENT	MATERIAL
1	Body	Lead Free Brass
2	Grip Ring	Stainless Steel
3	Tamper Lock	POM
4	Collapsible Ring	Nylon 6-6
5	Push Ring	POM
6	Spacer Gland	Nylon 6-6
7	O-Ring Seal	EPDM70

FORCES FOR MECHANICAL SEPARATION TEST

NOMINAL SIZE		LONGITUDINAL (PULL) TEST	
Inches	mm	Lbf	N
3/8 or <	10 or <	100.0	444.8
1/2	13	150.0	667
3/4	19	275.0	1223.2
1	25	475.0	2112.8
1-1/4	32	700.0	3113.6
1-1/2	38	1000.0	4446.0
2	51	1675.0	7445.4



*A Hi-flow™ tube stiffener should be used when connecting PEX tube.

PROPRIETARY AND CONFIDENTIAL

THE INFORMATION CONTAINED IN THIS DRAWING IS THE SOLE INTELLECTUAL PROPERTY AND COPYRIGHT OF QUICK FITTING INC. ANY TRANSMISSION, DUPLICATION OR REPRODUCTION IN PART OR WHOLE WITHOUT THE WRITTEN CONSENT OF QUICK FITTING INC. IS PROHIBITED.