

Specification Sheet

Model # : LF856 Lead Free 1-1/4" PC End Stop

1. Construction: Forged Lead Free and Low Lead Brass
2. Working Pressure 250 PSI Max
3. Temperature Rating 250 °F Max
4. Tested and certified by IAPMO 200 °F/ 200 PSI

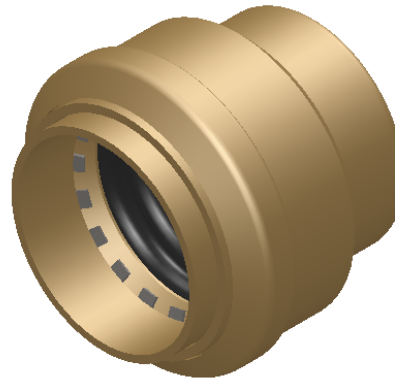
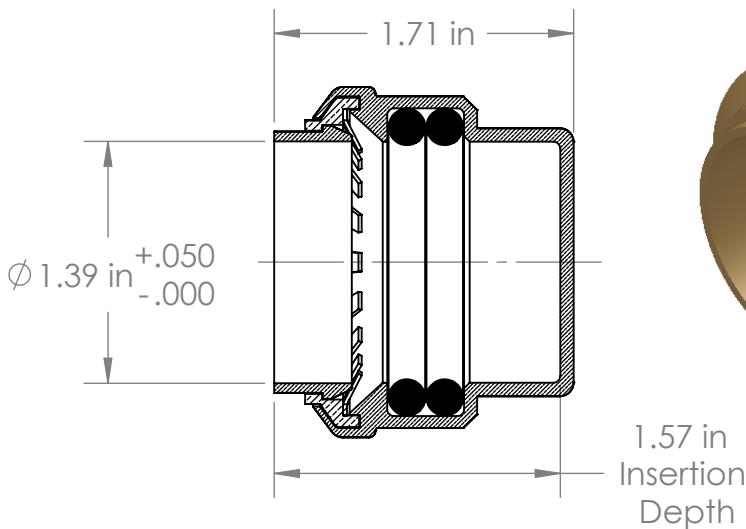
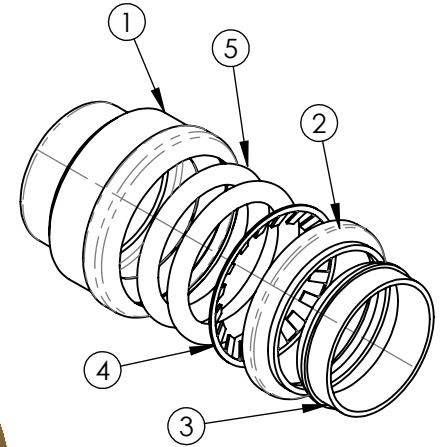

Approved Applications:

- Plumbing
- Heating
- Irrigation
- Underground
- Hydronic Heating
- Behind Walls without Access Panel

Features:

- Dual Seal
- 75 Year Warranty
- Compatible With Copper, CPVC, PEX & PE-RT
- Push to Connect
- Lead Free Brass
- Full Flow
- Removable
- Re-usable
- Replaceable O-Ring Seal Design

FORCES FOR MECHANICAL SEPARATION TEST

NOMINAL SIZE		LONGITUDINAL (PULL) TEST	
Inches	mm	Lbf	N
3/8 or <	10 or <	100.0	444.8
1/2	13	150.0	667
3/4	19	275.0	1223.2
1	25	475.0	2112.8
1-1/4	32	700.0	3113.6
1-1/2	38	1000.0	4446.0
2	51	1675.0	7445.4

MATERIALS & SPECIFICATIONS

NO.	COMPONENT	MATERIAL
1	Body	Lead Free Brass
2	Seat Ring	Lead Free Brass
3	Push Ring	Lead Free Brass
4	Grip Ring	Stainless Steel
5	O-Ring Seal	EPDM70
6		

Certifications

- cUPC
- ASSE1061-2011
- NSF/ANSI61
- IAPMO Listed
- Lead Law Compliant

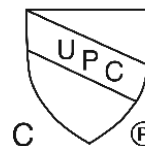

*A ProBite hi-flow tube stiffener should be used when connecting to PEX tube.

PROPRIETARY AND CONFIDENTIAL

THE INFORMATION CONTAINED IN THIS DRAWING IS THE SOLE INTELLECTUAL PROPERTY AND COPYRIGHT OF QUICK FITTING INC. ANY TRANSMISSION, DUPLICATION OR REPRODUCTION IN PART OR WHOLE WITHOUT THE WRITTEN CONSENT OF QUICK FITTING INC. IS PROHIBITED.