

Specification Sheet

Model # : CHT434
Copper 3/4" PC X 1/2" PC X 3/4" PC Reducing Tee

- **Material: Lead Free Copper**
- **Maximum: Working Pressure 250 PSI [17.3 bars]**
- **Maximum: Temperature Rating 250 °F [121 °C]**

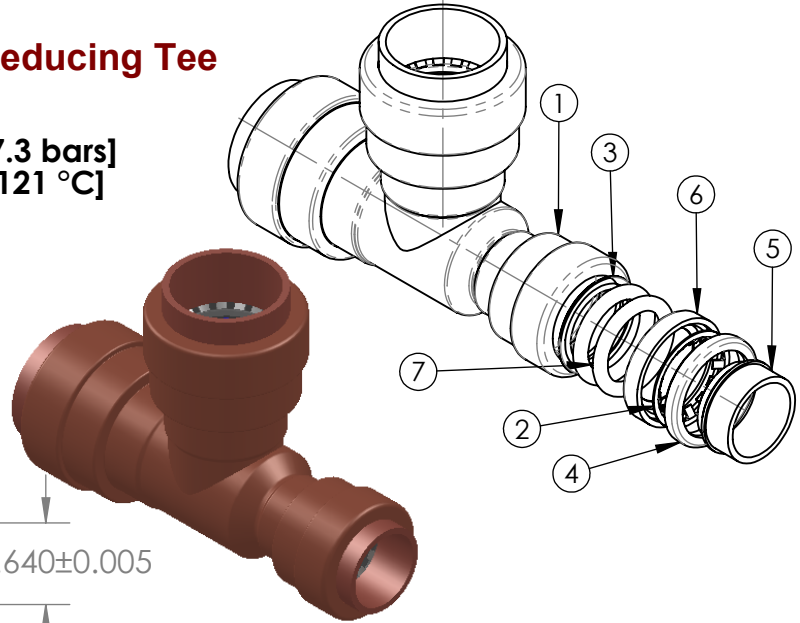
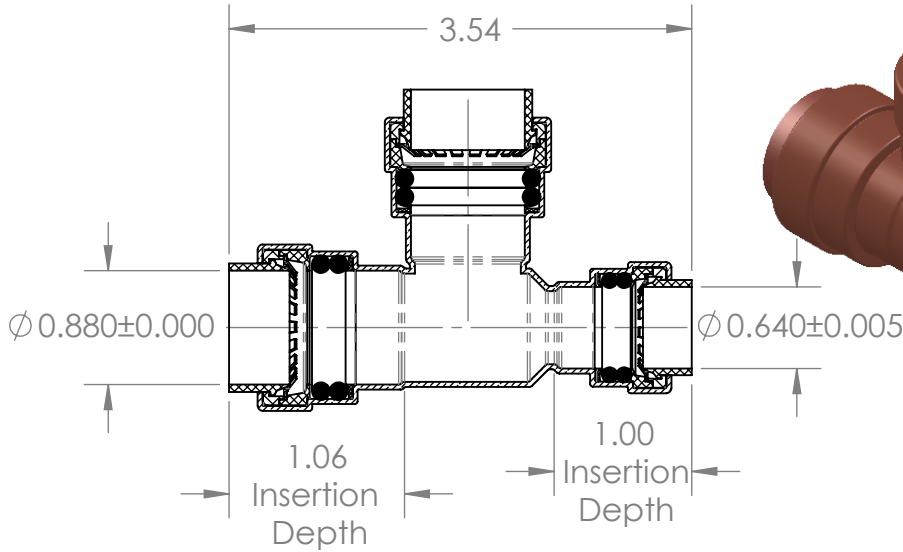

Approved Applications:

- Plumbing
- Heating
- Irrigation
- Underground
- Hydronic Heating
- Behind Walls without Access Panel

Features:

- Dual Seal
- 75 Year Warranty
- Compatible With Copper, CPVC, PEX & PE-RT
- Push to Connect
- Lead Free Copper
- Full Flow
- Removable
- Re-usable
- Replaceable O-Ring Seal Design

MATERIALS & SPECIFICATIONS

NO.	COMPONENT	MATERIAL
1	Body	Copper
2	Grip Ring	Stainless Steel
3	O-Ring Spacer	Nylon 6-6
4	Seat Ring	Nylon 6-6
5	Push Ring	POM
6	Spacer Gland	Nylon 6-6
7	O-Ring Seal	EPDM70
8		

FORCES FOR MECHANICAL SEPARATION TEST

NOMINAL SIZE		LONGITUDINAL (PULL) TEST	
Inches	mm	Lbf	N
3/8 or <	10 or <	100.0	444.8
1/2	13	150.0	667
3/4	19	275.0	1223.2
1	25	475.0	2112.8
1-1/4	32	700.0	3113.6
1-1/2	38	1000.0	4446.0
2	51	1675.0	7445.4

Certifications

- cUPC
- ASSE1061 - 2011
- NSF/ANSI 61
- IAPMO Listed

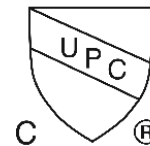

*A ProBite hi-flow tube stiffener should be used when connecting to PEX tube.

PROPRIETARY AND CONFIDENTIAL

THE INFORMATION CONTAINED IN THIS DRAWING IS THE SOLE INTELLECTUAL PROPERTY AND COPYRIGHT OF QUICK FITTING INC. ANY TRANSMISSION, DUPLICATION OR REPRODUCTION IN PART OR WHOLE WITHOUT THE WRITTEN CONSENT OF QUICK FITTING INC. IS PROHIBITED.



Overbuilt, not Overpriced!®