

Specification Sheet

3/4" PC X 3/4" PC Straight Coupling Brass
Part #: PB821

- 75-Year Warranty
- Full Flow
- Removable
- Re-usable

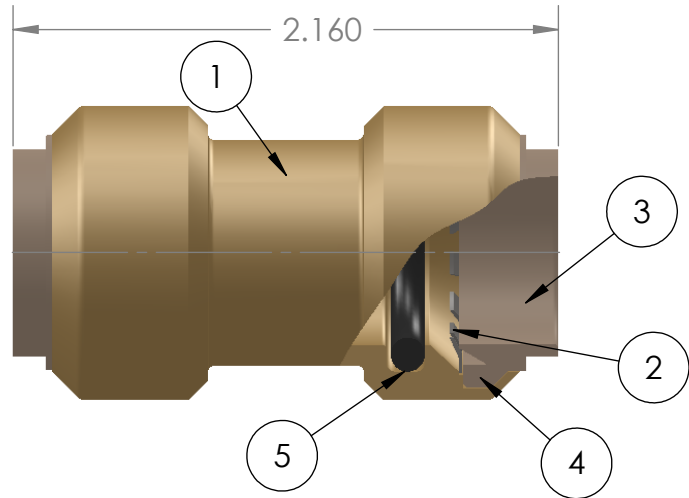
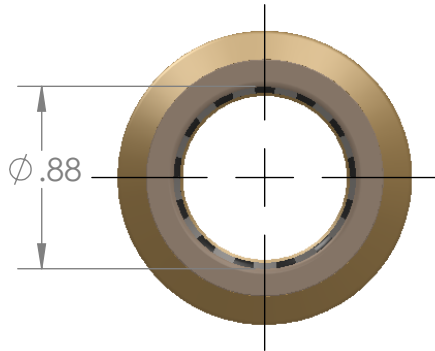

FEATURES AND BENEFITS

Push to connect joining for instant, trouble-free connection in dry or wet plumbing applications.

No soldering, clamps, unions or glues required.

Available in low lead and lead-free compliant materials.

PERFORMANCE:

Max Pressure.....200 psi

Max Temperature....350° F

Service.....Hot/Cold Water

Approved for plumbing, heating, irrigation, underground and behind walls with no access panels.

Tested and certified to UPC, cUPC, ASSE1061, NSF/ANSI 61, IPC, IAMP MO TESTED 200° F/ 200 PSI

Connect Copper, CPVC and *PEX

**A ProBite hi-flow tube stiffener should be used when connecting PEX tubing.*

Materials & Specifications

ITEM #	DESCRIPTION	MATERIAL
1	BODY	C36500, FORGED BRASS
2	GRIP RING	S.S. 301 - 304
3	RELEASE RING	POM
4	SEAT RING	POM
5	SEAL	EPDM 70
6		
7		
8		
9		
10		

Forces for Mechanical Separation Test

NOMINAL SIZE		LONGITUDINAL (Pull) TEST	
Inches	mm	lbf	N
3/8 or <	10 or <	100.0	444.8
1/2	13	150.0	667.2
3/4	19	275.0	1223.2
1	25	475.0	2112.8
1-1/4	32	700.0	3113.6
1-1/2	38	1000.0	4448.0
2	51	1675.0	7450.4

PROPRIETARY AND CONFIDENTIAL

THE INFORMATION CONTAINED IN THIS DRAWING IS THE SOLE INTELLECTUAL PROPERTY AND COPYRIGHT OF QUICK FITTING INC. ANY TRANSMISSION, DUPLICATION OR REPRODUCTION IN PART OR WHOLE WITHOUT THE WRITTEN CONSENT OF QUICK FITTING INC. IS PROHIBITED.