

Specification Sheet

Model # : LF922 3/4" X 3/4" Full Port Integrated Ball Valve

1. Construction: Forged Lead Free and Low Lead Brass
2. Working Pressure 200 PSI Max
3. Temperature Rating 200 °F Max
4. Tested and certified by IAPMO 200 °F/ 200 PSI

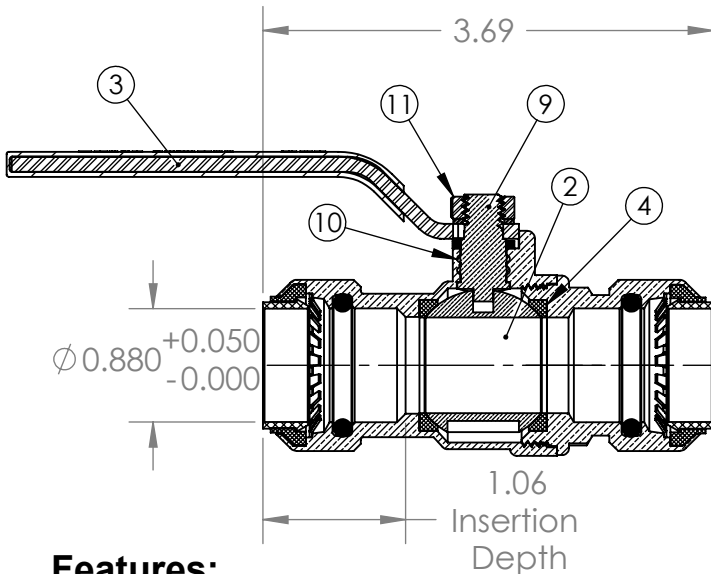

Features:

- Lead Free Compliant Materials
- 75 Year Warranty
- Compatible with Copper, CPVC, PEX & PE-RT
- Push to Connect
- Full Flow
- Removable
- Re-usable
- Replaceable O-Ring Seal Design

MATERIALS & SPECIFICATIONS

No	COMPONENT	MATERIAL
1	Body	Lead Free Brass
2	Ball	Chrome Plated
3	Handle	Chrome Plated
4	Seat	Nylon
5	Retaining Ring	POM
6	Release Ring	POM
7	Grip Ring	Stainless Steel
8	O-ring	EPDM
9	Stem	Lead Free Brass
10	Stem Seal	NBR
11	Nut	Stainless Steel

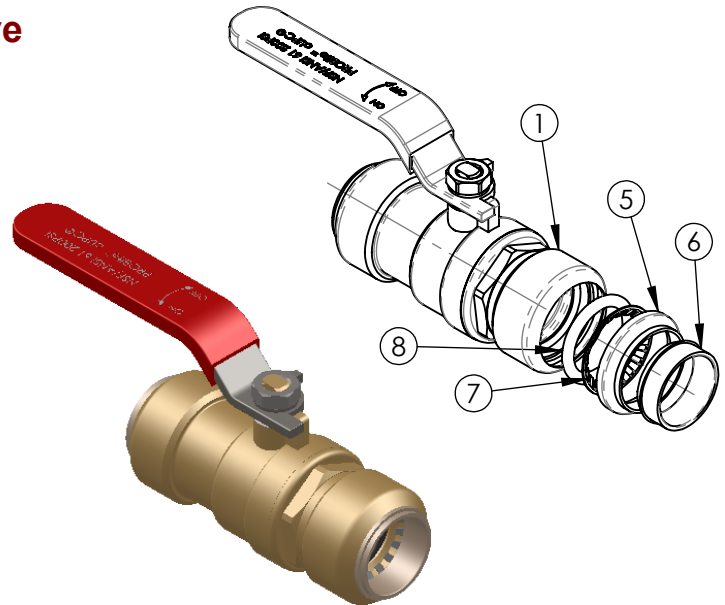

Approved Applications

- Plumbing
- Heating
- Irrigation
- Underground
- Hydronic Heating
- Behind Walls without Access Panel

FORCES FOR MECHANICAL SEPARATION TEST

NOMINAL SIZE		LONGITUDINAL (PULL) TEST	
Inches	mm	Lbf	N
3/8 or <	10 or <	100.0	444.8
1/2	13	150.0	667
3/4	19	275.0	1223.2
1	25	475.0	2112.8
1-1/4	32	700.0	3113.6
1-1/2	38	1000.0	4446.0
2	51	1675.0	7445.4

Certifications

- cUPC
- ASSE1061 -2011
- NSF/ANSI61
- IAPMO Listed
- Lead Law Compliant

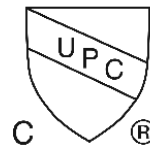

*A ProBite hi-flow tube stiffener should be used when connecting to PEX tube.

PROPRIETARY AND CONFIDENTIAL

THE INFORMATION CONTAINED IN THIS DRAWING IS THE SOLE INTELLECTUAL PROPERTY AND COPYRIGHT OF QUICK FITTING INC. ANY TRANSMISSION, DUPLICATION OR REPRODUCTION IN PART OR WHOLE WITHOUT THE WRITTEN CONSENT OF QUICK FITTING INC. IS PROHIBITED.