

Specification Sheet

Model #: LF756A

1/2" Angle Valve X 7/8" Plastic Connect, 12" Toilet Connect Hose

- 5-Year Warranty
- Full Flow
- Removable
- Re-usable
- Duo Seal
- Push Lock

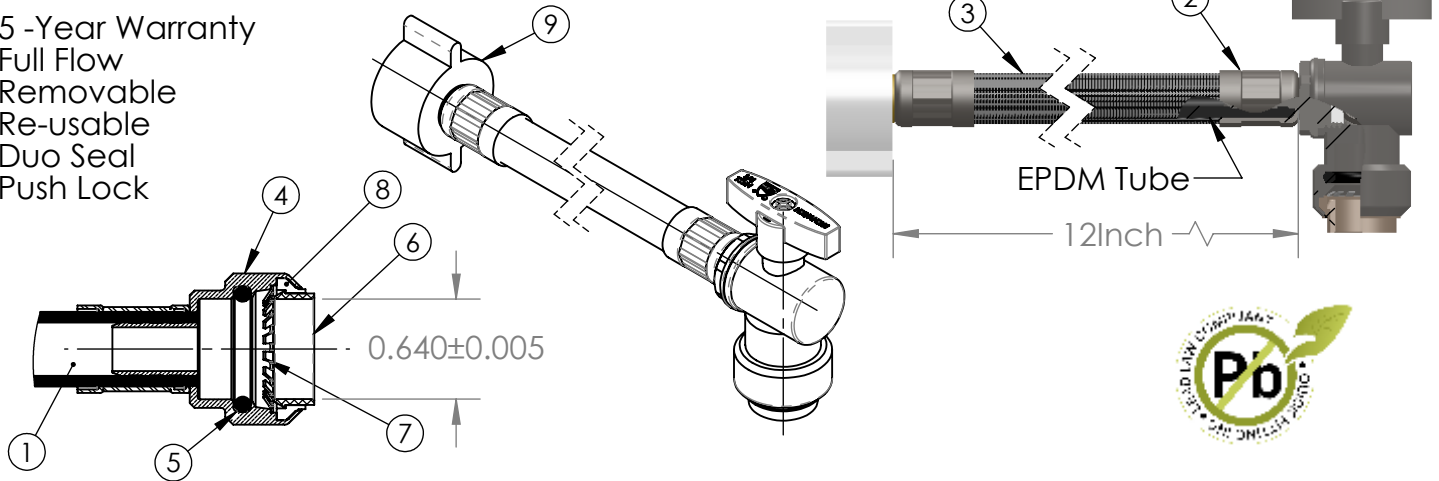

FEATURES AND BENEFITS

Push to connect joining for instant, trouble-free connection in dry or wet plumbing applications.

No soldering, clamps, unions or glues required.
 Available in low lead and lead-free compliant material

PERFORMANCE:

Max. Pressure..... 200 psi
 Decomposition Temperature.... 482 °F
 Service Temperature..... 248 °F
 Flash Point..... 572 °F
 Burst Pressure..... 800 psi

FORCES FOR MECHANICAL SEPARATION TEST

NOMINAL SIZE		LONGITUDINAL (PULL) TEST	
Inches	mm	lbf	N
3/8 or <	10 or <	100.0	444.8
1/2	13	150.0	667
3/4	19	250.0	1223.2

Approved for plumbing and heating application.

Connect Copper, CPVC and *PEX

Push Fitting tested and certified to UPC, cUPC, ASSE1061, IPC, IAMP MO TESTED 200 °F/ 200 PSI

**A ProBite hi-flow tube stiffener should be used when connecting to PEX tube.*

MATERIALS & SPECIFICATIONS

ITEM #	DESCRIPTION	MATERIAL
1	Rubber Hose	EPDM 70 Perox
2	Ferrule	Stainless Steel 304
3	Hose Braiding	Stainless Steel 304
4	Fitting Head	Lead Free Brass
5	O-ring	EPDM 70 Perox
6	Push Release	POM
7	Grip Ring	Stainless Steel
8	Seat Ring	POM
9	Nut	PTFE

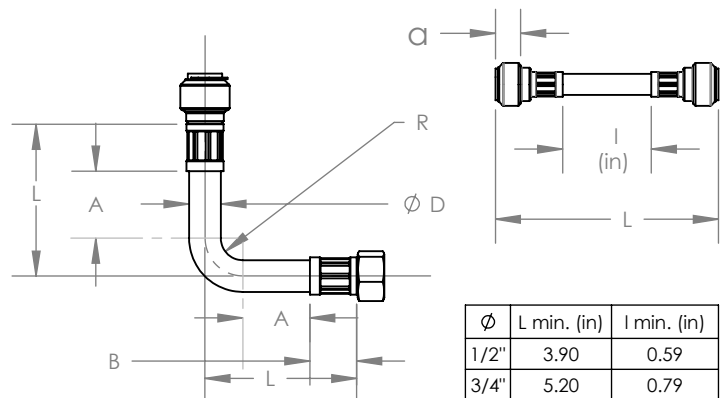

NOMINAL DIAMETER AND BENDING RADIUS

Ø (in)	R (in)	A (in)	B (in)	L (α=90°)
1/2	1.38	1.38	1.06	106
3/4	2.17	2.17	1.38	159

PROPRIETARY AND CONFIDENTIAL

THE INFORMATION CONTAINED IN THIS DRAWING IS THE SOLE INTELLECTUAL PROPERTY AND COPYRIGHT OF QUICK FITTING INC. ANY TRANSMISSION, DUPLICATION OR REPRODUCTION IN PART OR WHOLE WITHOUT THE WRITTEN CONSENT OF QUICK FITTING INC. IS PROHIBITED.